

**COIL - TUBE Ø 13**

**20,5 W**

- Wire insulation class.....H (>185°C)
- ED.....100%
- Coil power at 20° C.....20,5 W
- Ambient temperature.....-20 +40° C
- Weight.....0,16 Kg

**ELECTRIC CIRCUITS**

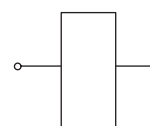

**STANDARD**

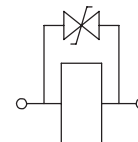

**WITH DIODE  
(BI-DIRECTIONAL)**

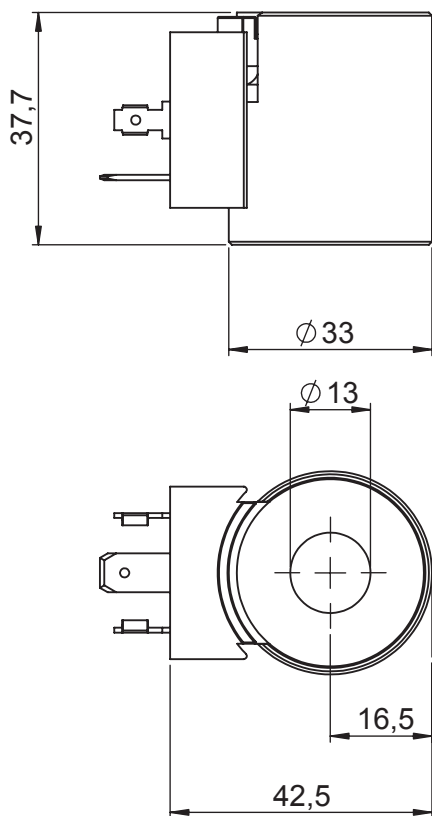

**DEUTSCH DT4**

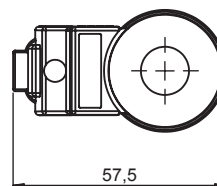
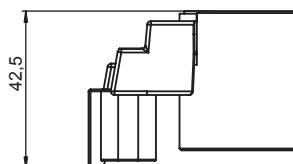

**AMP - JUNIOR**

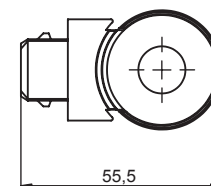
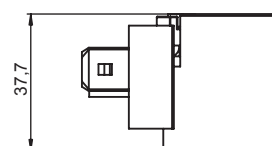

**Note:**

- Coil interchangeable with CT-9200 model.

CONNECTOR	PROTECTION CLASS	COIL THERMAL INSULATION CLASS	VOLTAGE [V]	RESISTANCE [Ω]	CIRCUIT	ORDERING CODE
DIN 43650	IP65*	H	12 V dc	7	STANDARD	<b>094001000</b>
DIN 43650	IP65*	H	24 V dc	28	STANDARD	<b>094002000</b>
DEUTSCH DT 4	IP67	H	12 V dc	7	WITH DIODE	<b>094101000</b>
DEUTSCH DT 4	IP67	H	24 V dc	28	WITH DIODE	<b>094102000</b>
AMP - JUNIOR	IP65*	H	12 V dc	7	STANDARD	<b>094201000</b>
AMP - JUNIOR	IP65*	H	24 V dc	28	STANDARD	<b>094202000</b>

\* Protection index with standard connector

